

INSTALLATIONSVEJLEDNING
MONTAGEANWEISUNG
INSTALLATION INSTRUCTION
INSTRUCTIONS D'INSTALLATION
INSTALLATIE INSTRUCTIES
ISTRUZIONI DI INSTALLAZIONE
INSTRUCCIONES DE INSTALACIÓN

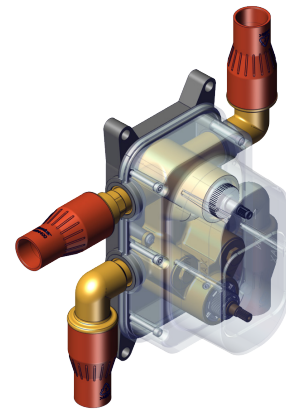

Rev. 002
 2023-02-03
 2030600

CONCEALED
 Thermostatic Mixer

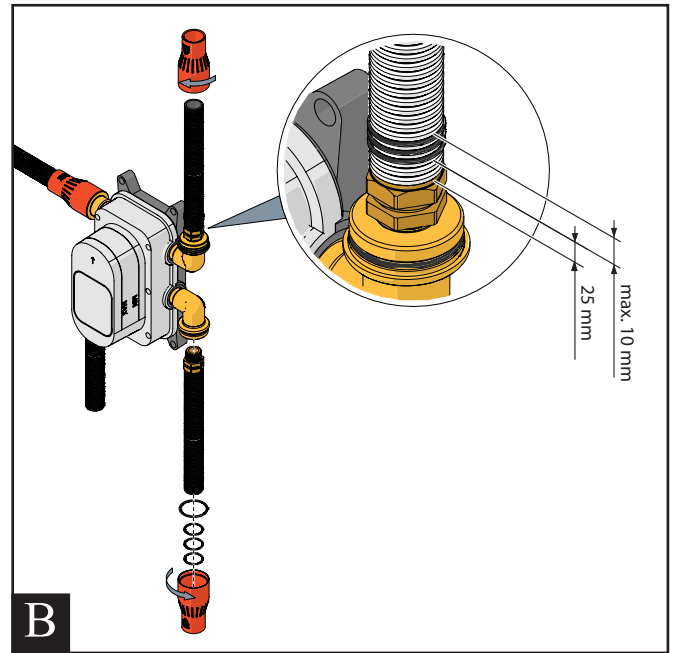
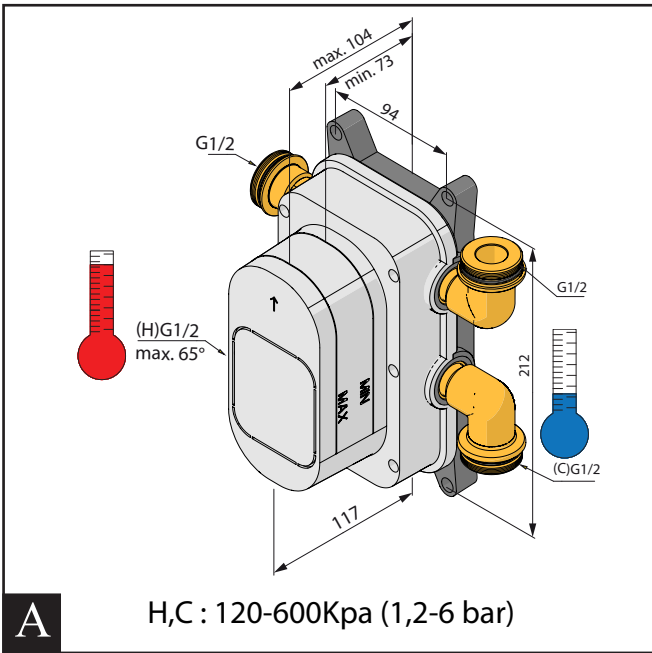

INSTALLATION

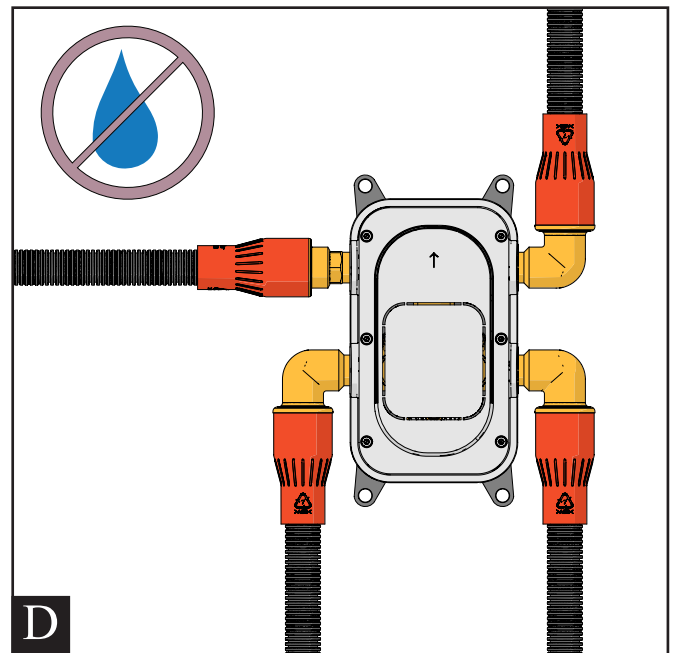
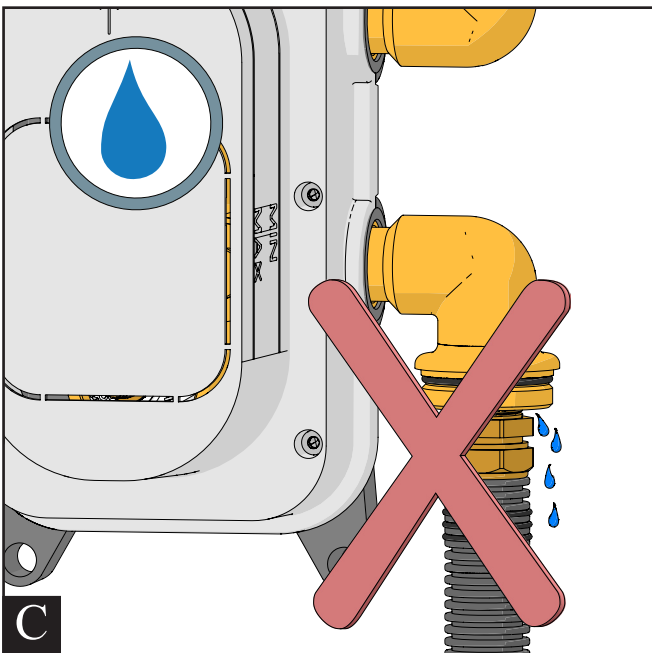

FM Mattsson Denmark ApS
 Hvidkærvej 48, 5250 Odense SV
 Abildager 26a, 2605 Brøndby
 Tlf. +45 88 33 00 34
 damixa-international@fmmattssongroup.com
 www.damixa.com

damixa

INSTALLATION

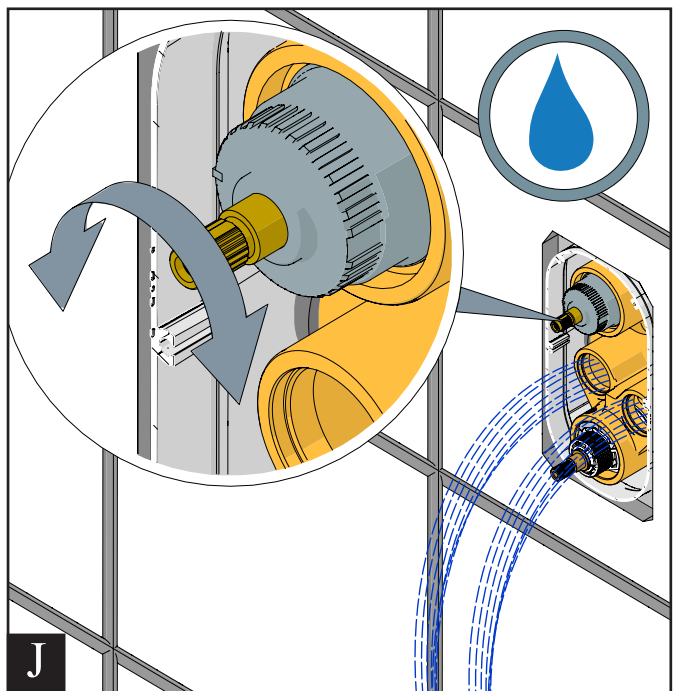
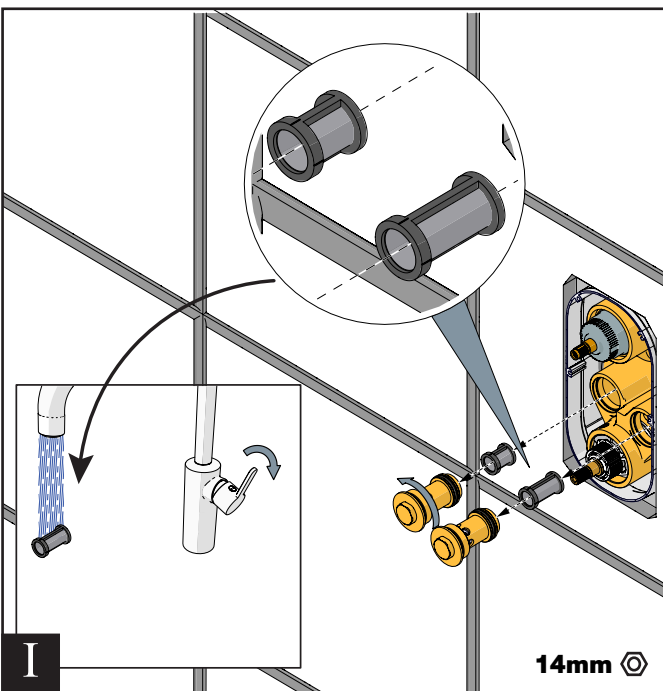
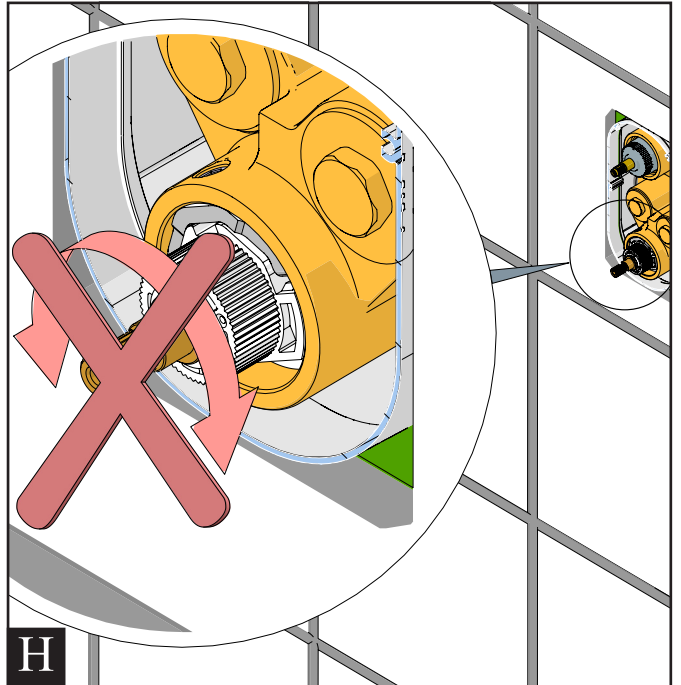
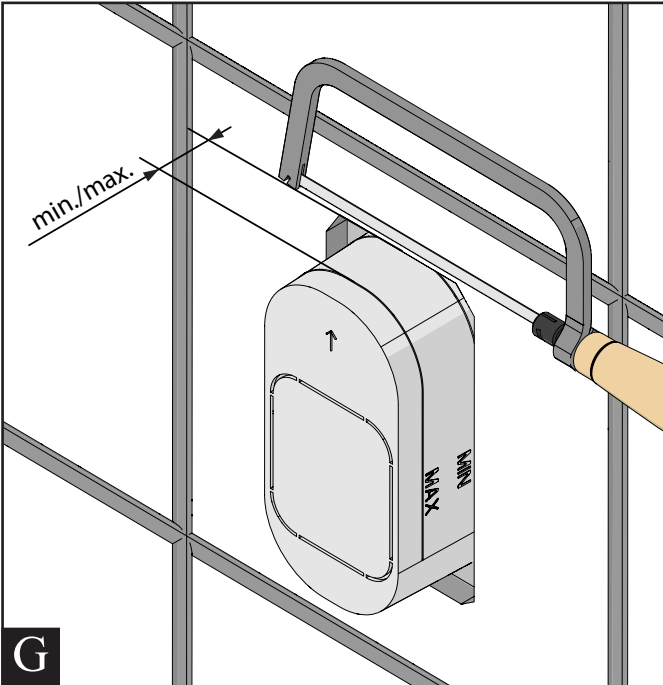
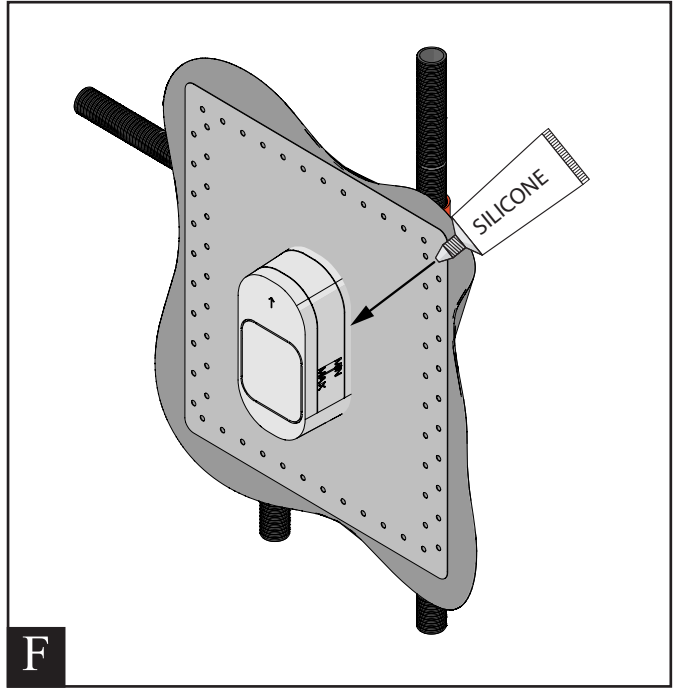
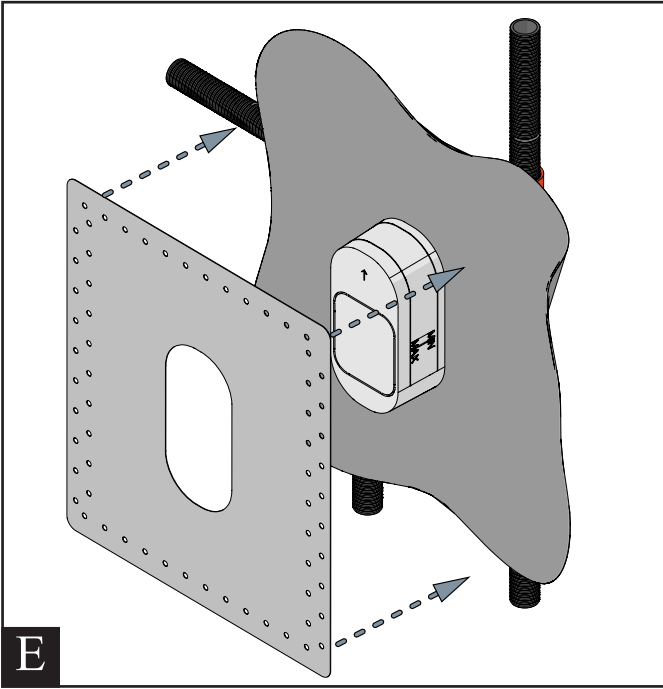

INSTALLATION

