

14887

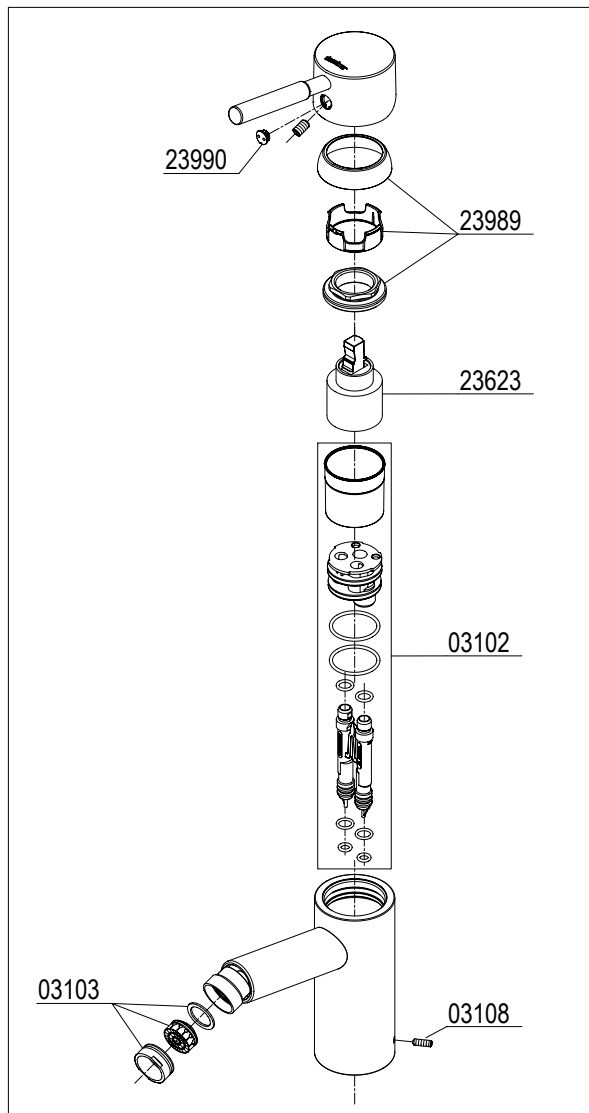

14882

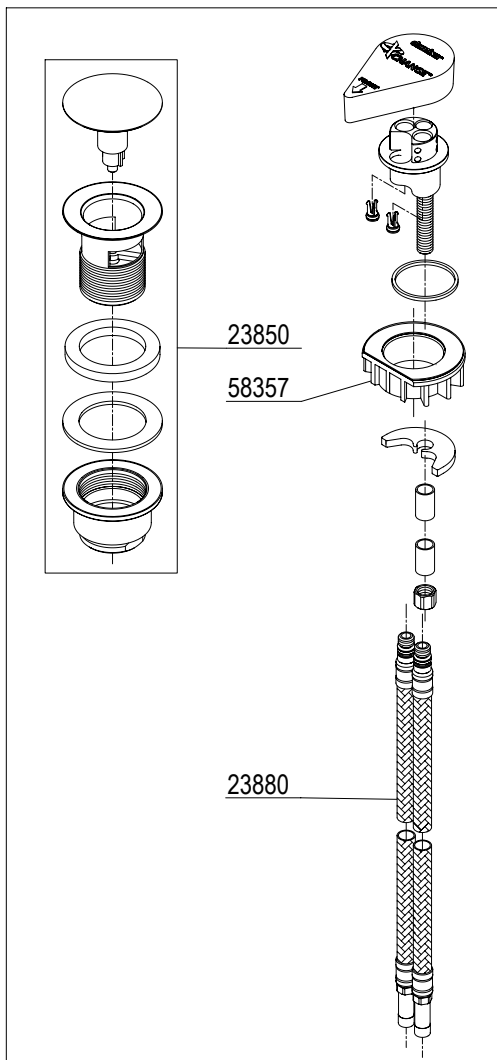

48221