

Rev. 001

11/04/2024

2035200

**Installationsvejledning
Montageanweisung
Installation instruction
Instructions d'installation
Installatie instructies
Istruzioni di installazione
Instrucciones de instalación**

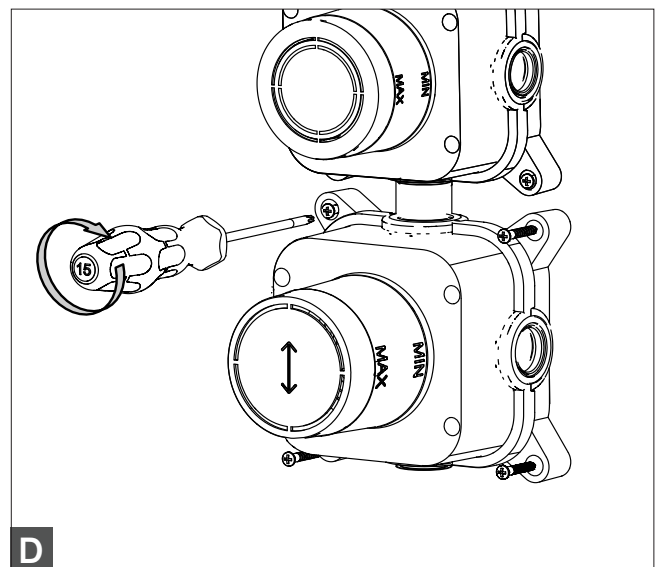
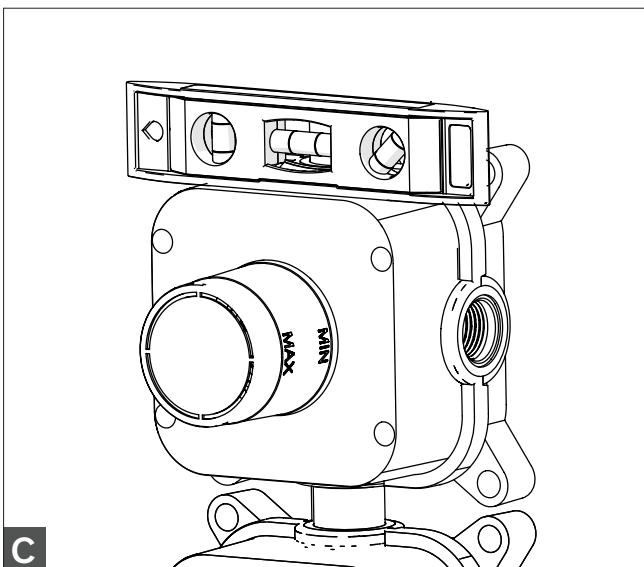
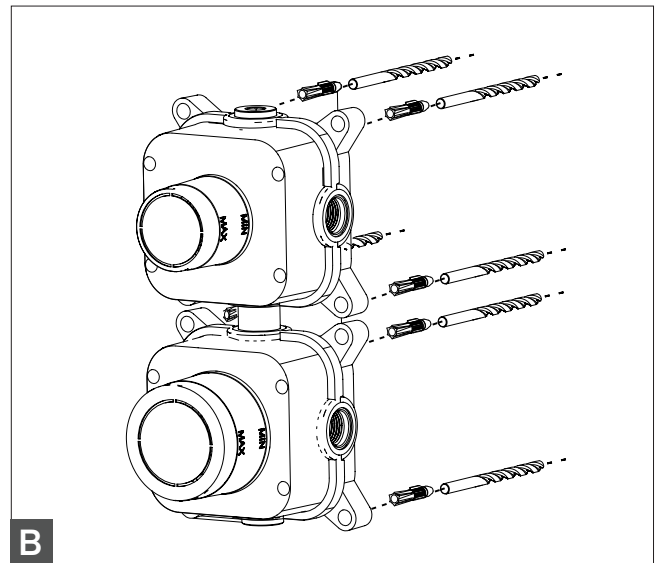
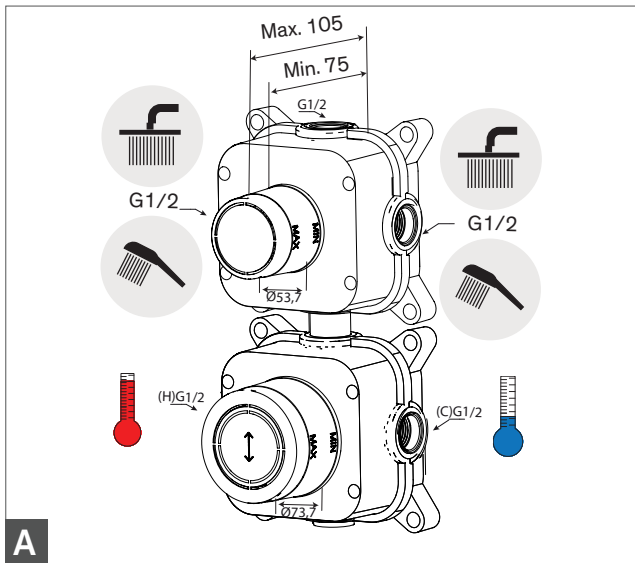

INSTALLATION

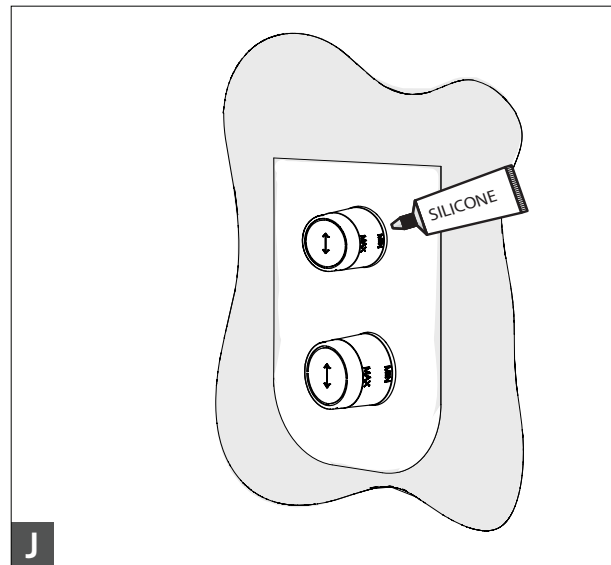
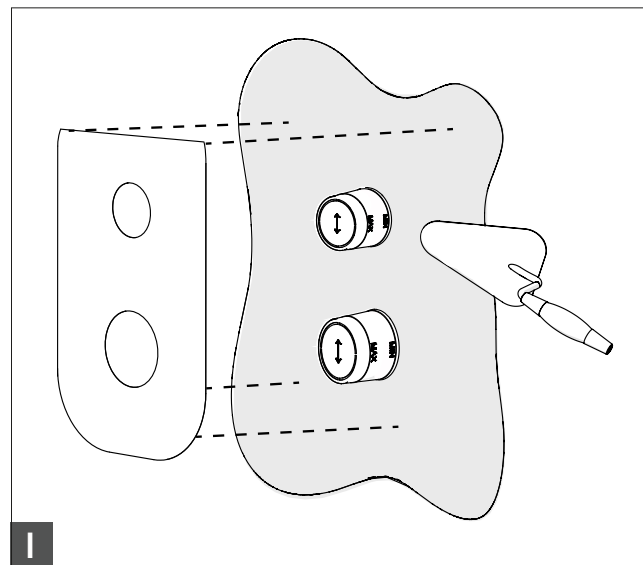
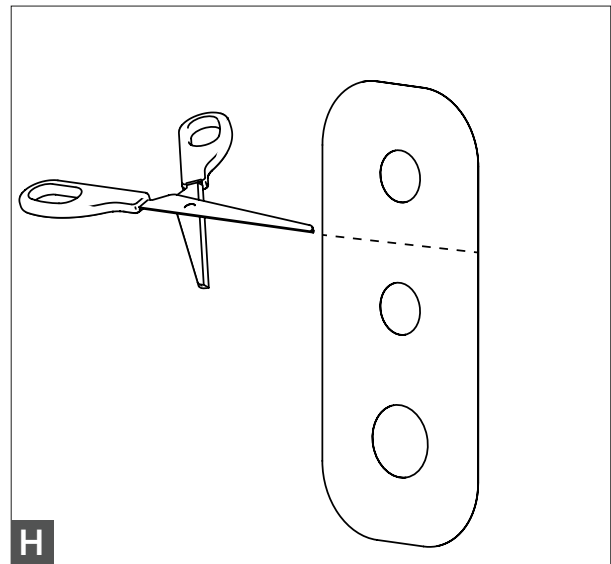
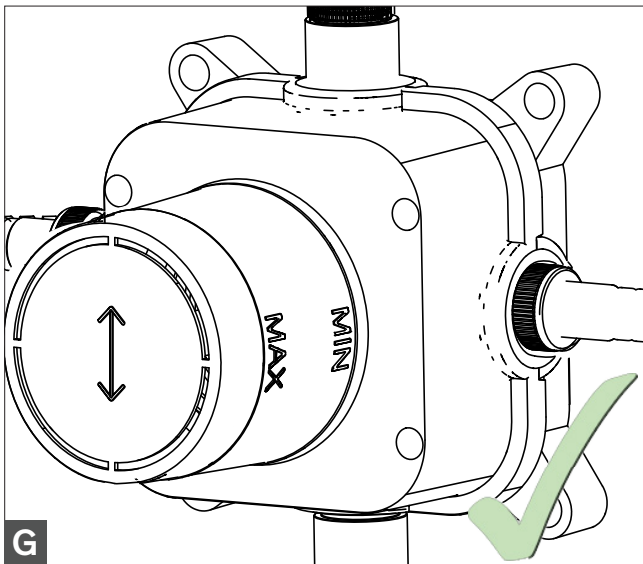
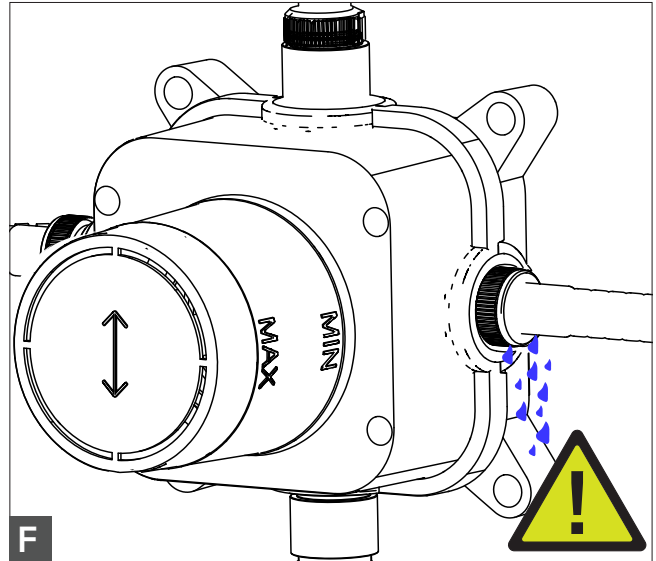
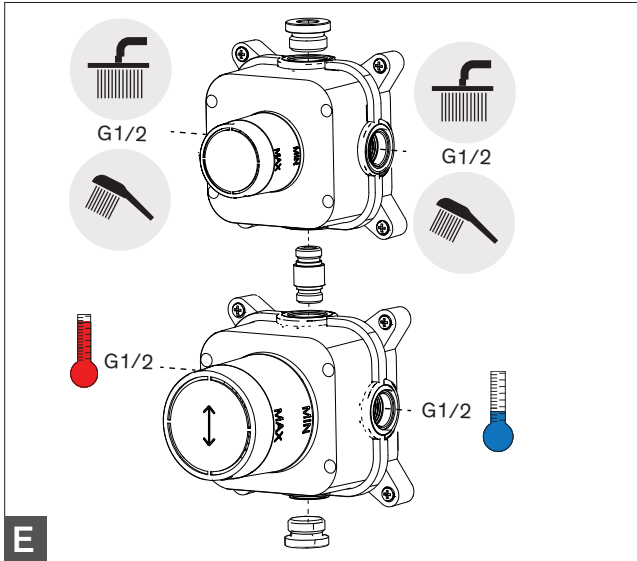

INSTALLATION

